

AUTO-HAK Sp. z o.o.

ul. Słoneczna 16K 76-200 SŁUPSK
POLAND

tel/fax +48 59 8 414 414; +48 59 8 414 413

e-mail: office@autohak.com.pl

www.autohak.com.pl



AUTO-HAK

OPEL GRANDLAND



10.2024 →

Nr kat.

E70V



55R-03 7083



2h

D

10,9 kN

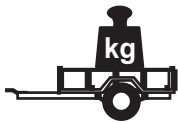

R=2000 kg



S=80 kg

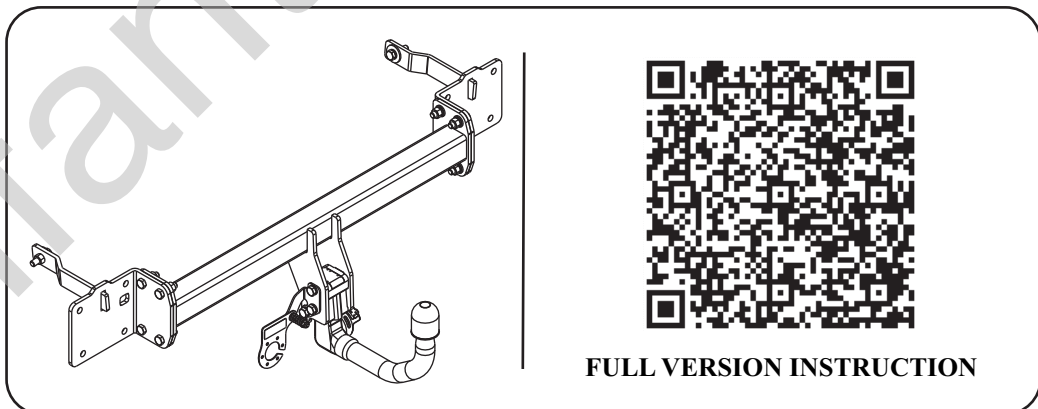

FULL VERSION INSTRUCTION



śruba	Nm	M6	M8	M10	M12	M14	M16
klasa 8.8		9,9	24	48	83	132	200
klasa 10.9		14	34	67	117	185	285









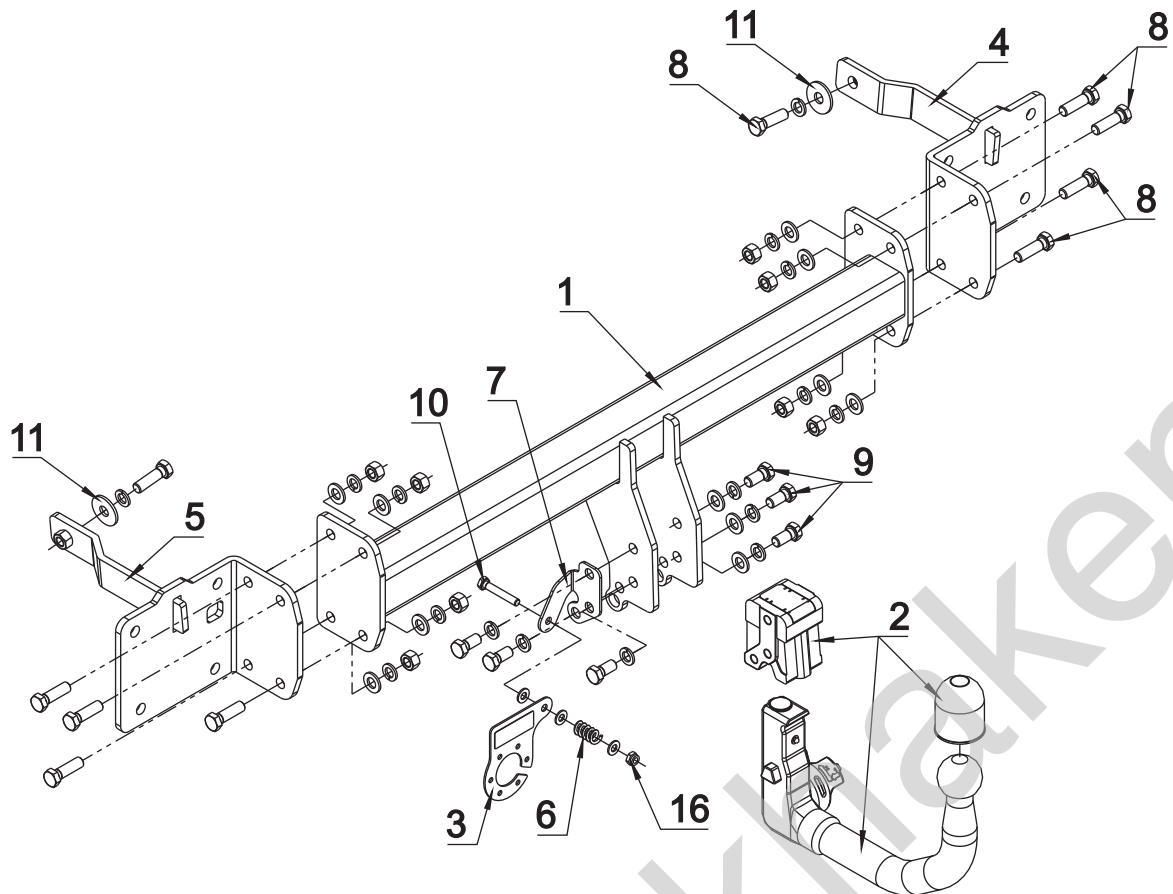

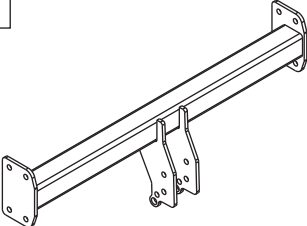



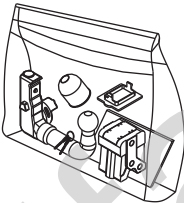

0 km



1000 km

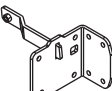

 1	x 1	 8	M12x40	x 10		
			 9	M12x25	x 6	
				 10	M8x50	x 1
					 11	ϕ 37x ϕ 13x3 13 DIN 9021
 2 Art.nr-KL1E70V	x 1	 12	ϕ 13	x 11		
			 13	ϕ 8.4	x 3	
				 14	ϕ 12.2	x 16
 3 Art.nr-BL12E70V	x 1	 15	M12	x 8		
 4	x 1	 16	M8 (DIN985)	x 1		
 5	x 1					
 6	x 1					
 7	x 1					

