

AUTO-HAK Sp. z o.o.

ul. Słoneczna 16K 76-200 SŁUPSK
POLAND

tel/fax +48 59 8 414 414; +48 59 8 414 413

e-mail: office@autohak.com.pl

www.autohak.com.pl

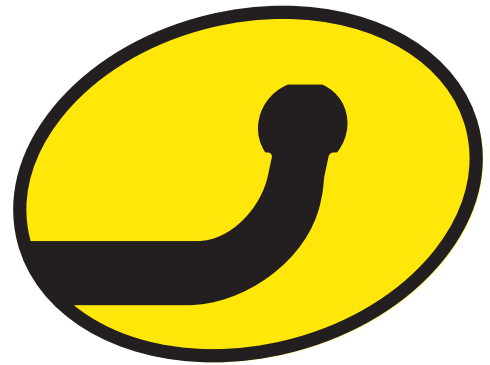

AUTO-HAK

**LAND ROVER
RANGE ROVER EVOQUE (L538)**

Nr kat.
LN04V

 06.2011 → 12.2018

 **E20** E20-55R-01 4865

D 10,0 kN

 **R=1800 kg**

 **S=150 kg**

 **2h**

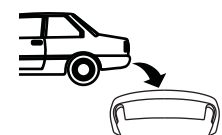



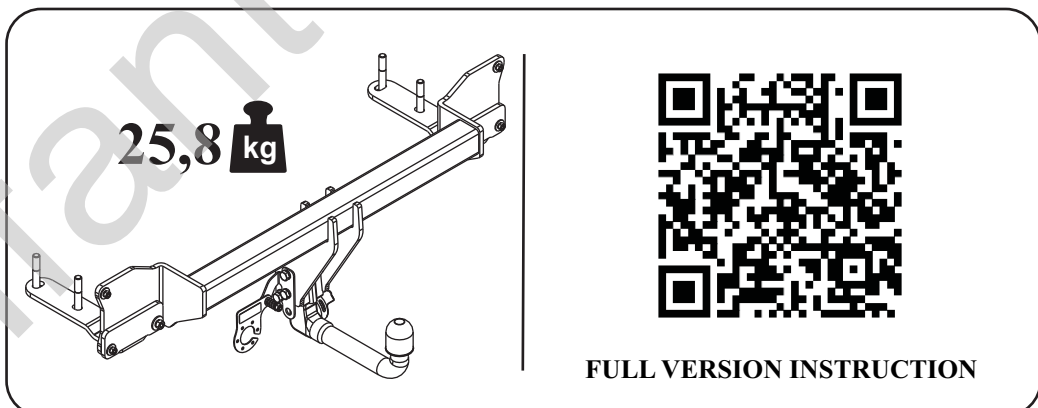





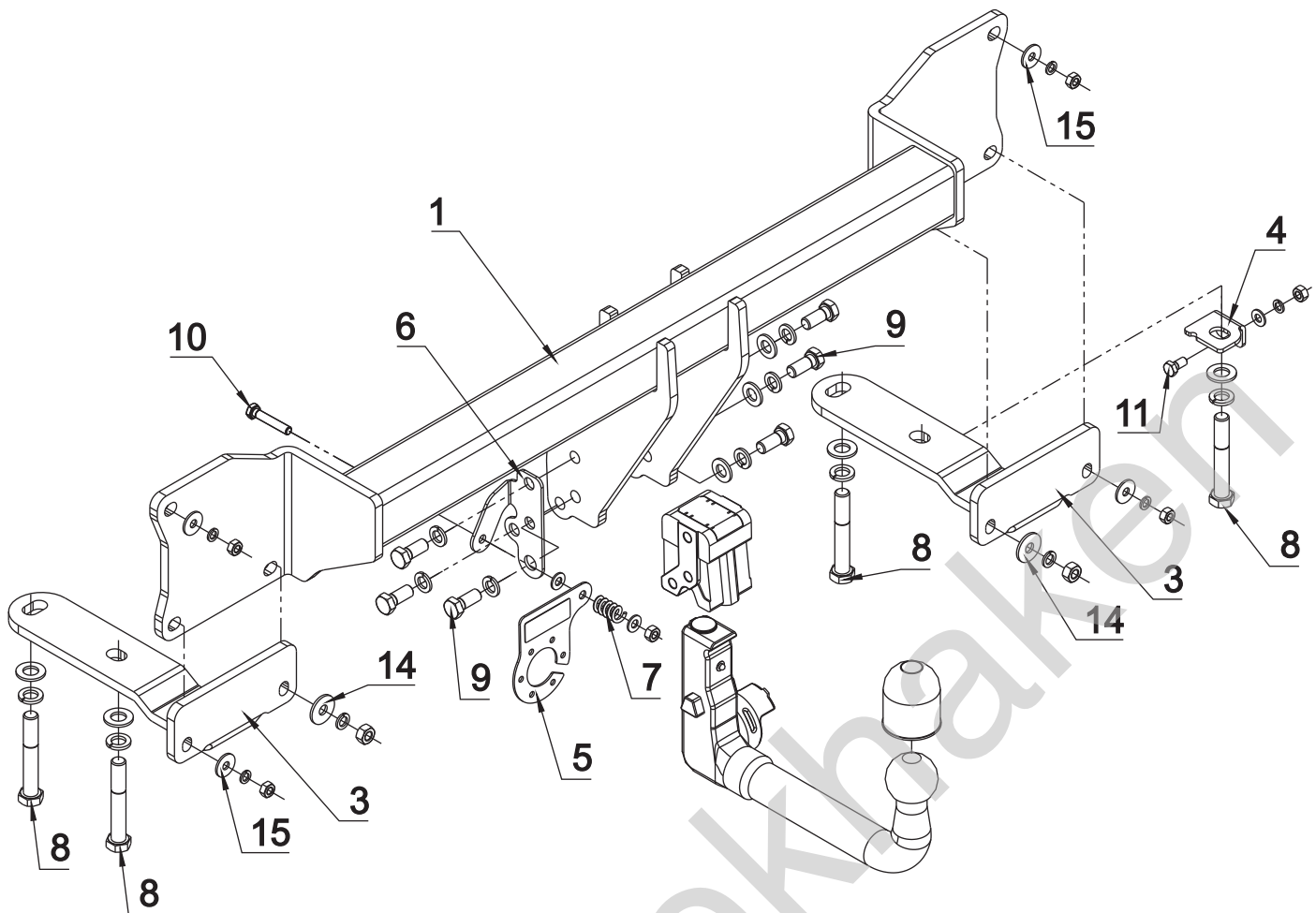

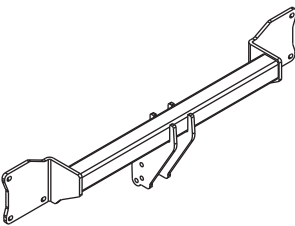

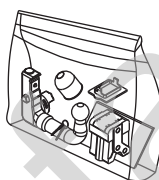

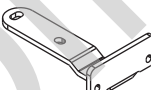

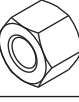

śruba	Nm	M6	M8	M10	M12	M14	M16
klasa 8.8		9,9	24	48	83	132	200
klasa 10.9		14	34	67	117	185	285

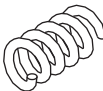
 0 km →  1000 km



1		x1		8 M14x90	x4
2	 Art.nr-KL1LN04V	x1		9 M12x28	x6
				10 M8x45	x1
3		x2		11 M8x16	x1
				12 \varnothing 15	x4
4		x1		13 \varnothing 13	x3
				14 \varnothing 30x \varnothing 10.5x2.5 10 DIN 9021	2
5	 Art.nr-BL1LN04V	x1		15 \varnothing 24x \varnothing 8.4x2 8 DIN 9021	4
				16 \varnothing 8.4	x3
6		x1		17 \varnothing 14.2	x4
				18 \varnothing 12.2	x6
7		x1		19 \varnothing 10.2	x2
				20 \varnothing 8.2	x5
8		x2		21 M10	x2
				22 M8	x6

