

AUTO-HAK Sp. z o.o.

ul. Słoneczna 16K 76-200 SŁUPSK
POLAND

tel/fax +48 59 8 414 414; +48 59 8 414 413

e-mail: office@autohak.com.pl

www.autohak.com.pl



AUTO-HAK

SKODA

FABIA I 5D (6Y), ~~RS~~

⌚ 01.2000 → 03.2007

FABIA II 5D (5J), ~~RS~~

⌚ 04.2007 → 05.2010

FABIA II 5D (5J), ~~RS~~

⌚ 06.2010 → 08.2014

Nr kat.

H10

E20 E20-55R-01 0678

D 7,0 kN

 R=1200 kg

 S=50 kg



2h

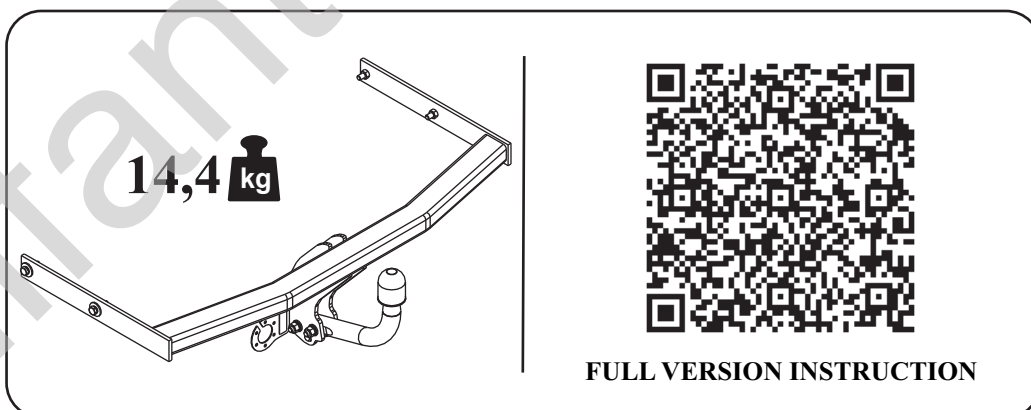
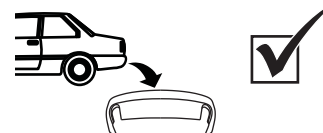









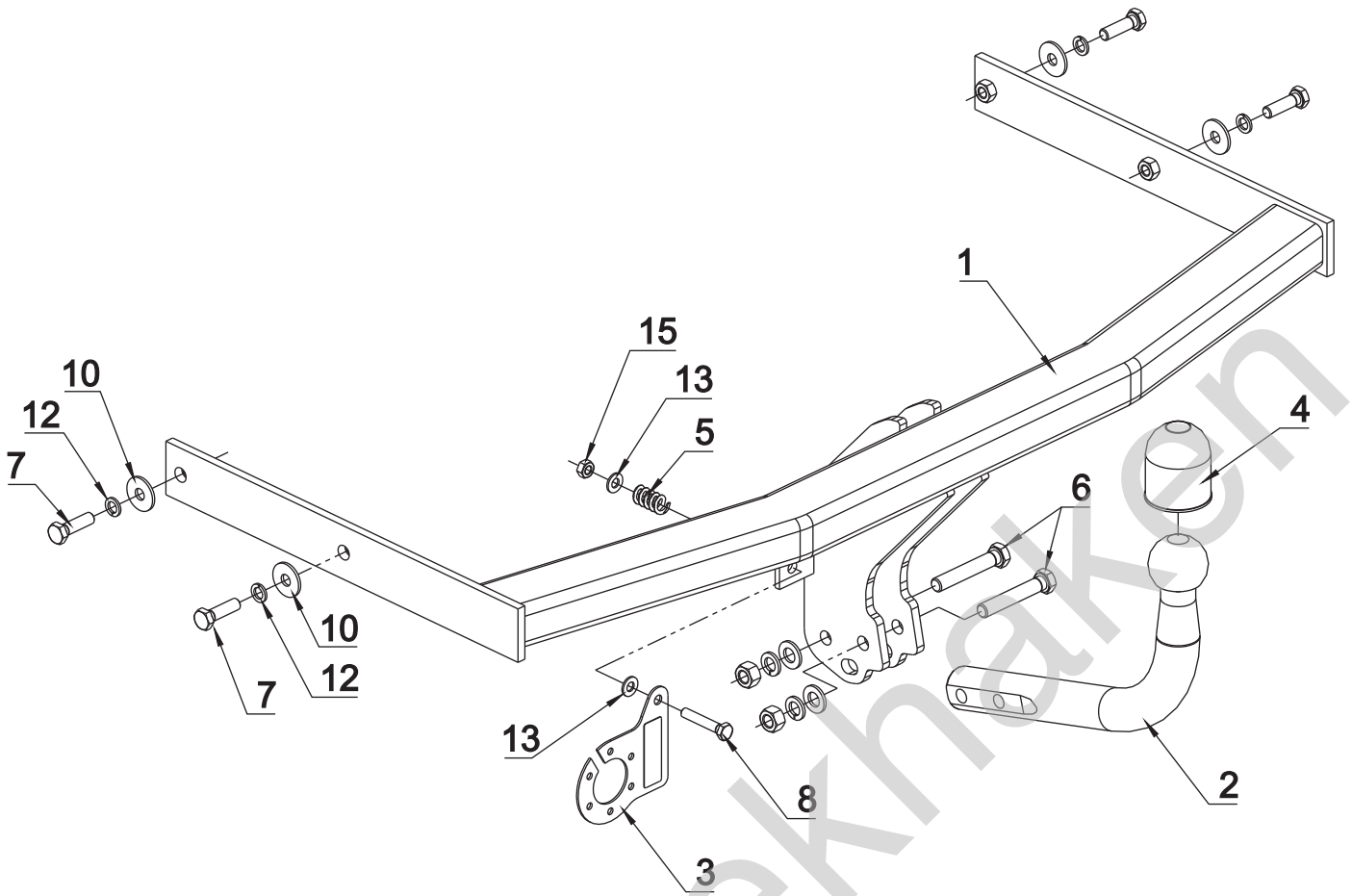

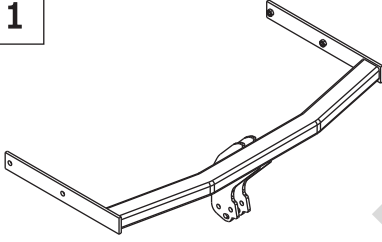
FULL VERSION INSTRUCTION

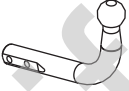

śruba	Nm	M6	M8	M10	M12	M14	M16
klasa 8.8		9,9	24	48	83	132	200
klasa 10.9		14	34	67	117	185	285

 0 km →  1000 km

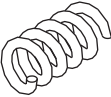

1		x1		6	M12x70	x2
				7	M10x35	x4
2		x1 Art.nr-KL1H10		8	M8x45	x1
				9	∅ 13	x2
3		x1 Art.nr-BL1H10		10	∅ 30x∅10.5x2.5 10 (DIN 9021)	x4
				11	∅ 12.2	x2
4		x1		12	∅ 10.2	x4
				13	∅ 8.4	x2
5		x1		14	M12	x2
				15	M8	x1

