

AUTO-HAK Sp. z o.o.

ul. Słoneczna 16K 76-200 SŁUPSK
POLAND

tel/fax +48 59 8 414 414; +48 59 8 414 413

e-mail: office@autohak.com.pl

www.autohak.com.pl



AUTO-HAK

FIAT PUNTO III
GRANDE PUNTO
(3/5 D. (199), ~~Abarth~~)

} 03.2006 → 07.2011

Cat. no:

R38A

FIAT PUNTO EVO
(3/5 D. (199), ~~Abarth~~)

10.2009 → 07.2011

FIAT PUNTO (3/5 D.) 08.2011 →



2h



E20-55R-01 3716

D

7,1 kN



R=1300 kg



S=75 kg

15,1 kg



M6 - 11 Nm
M10 - 50 Nm
M14 - 138 Nm

M8 - 25 Nm
M12 - 87 Nm
M16 - 210 Nm









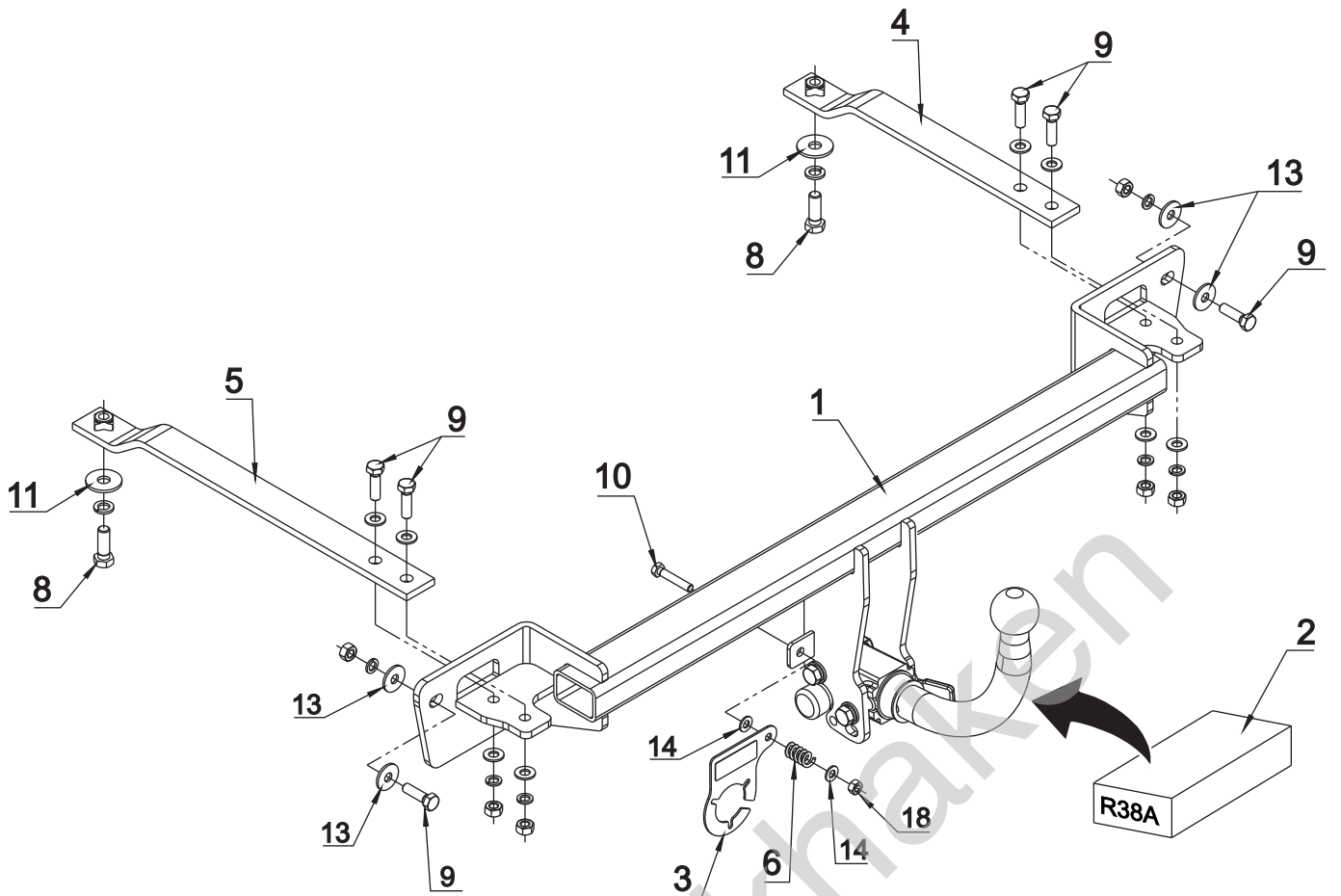

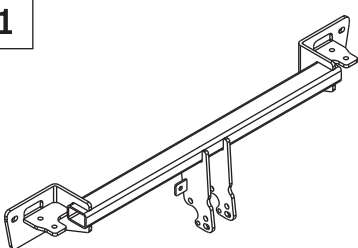
0 km →

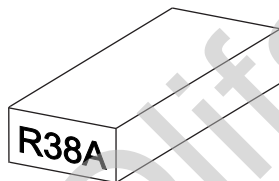

1000 km

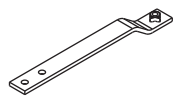
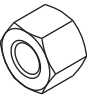
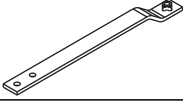
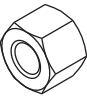
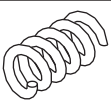

1		x 1		8 M 12x35	x 2
2	 R38A Art.nr-KL1R38A	x 1		9 M 10x35	x 6
				10 M 8x45	x 1
				11 ϕ 37x ϕ 13x3 13 (DIN 9021)	x 2
				12 ϕ 10.5	x 8
3	 Art.nr-BL1R38A	x 1		13 ϕ 30x ϕ 10.5x2.5 10 (DIN 9021)	x 4
				14 ϕ 8.4	x 2
4	 L=385mm	x 1		15 ϕ 12.2	x 2
				16 ϕ 10.2	x 6
5	 L=480mm	x 1		17 M 10	x 6
				18 M 8	x 1
6		x 1			
7		x 1			

