

# AUTO-HAK Sp. z o.o.

ul. Słoneczna 16K 76-200 SŁUPSK  
POLAND

tel/fax +48 59 8 414 414; +48 59 8 414 413

e-mail: [office@autohak.com.pl](mailto:office@autohak.com.pl)

[www.autohak.com.pl](http://www.autohak.com.pl)

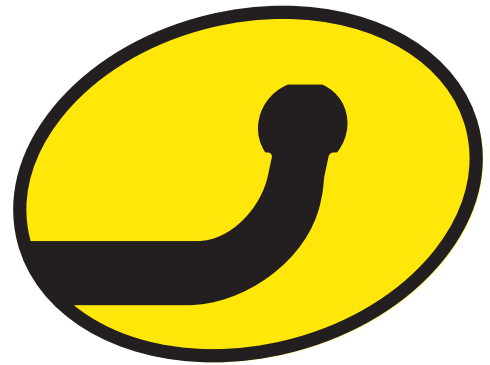

# AUTO-HAK

## BMW X1 (F48)

 10.2015 → 06.2022

Nr kat.

**B29V**

 **E20** E20-55R-01 5886

**D** 10,49 kN

 **R=2000 kg**

 **S=85 kg**

 **2h**

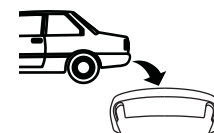



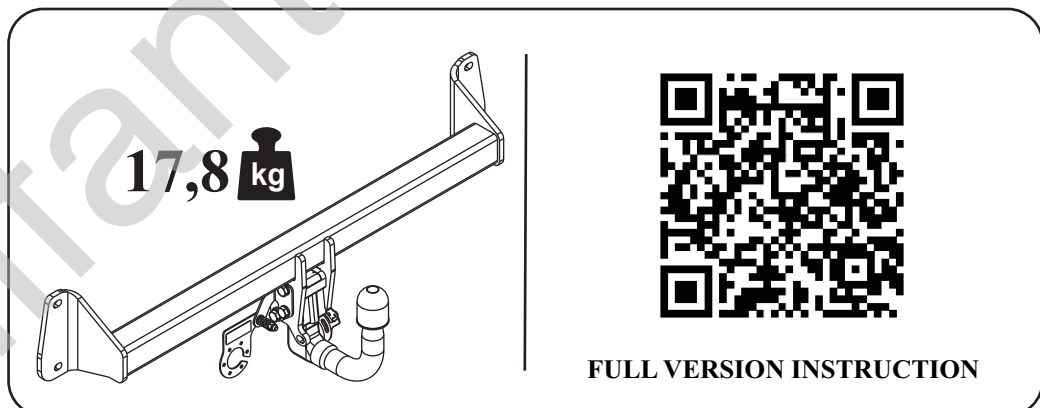





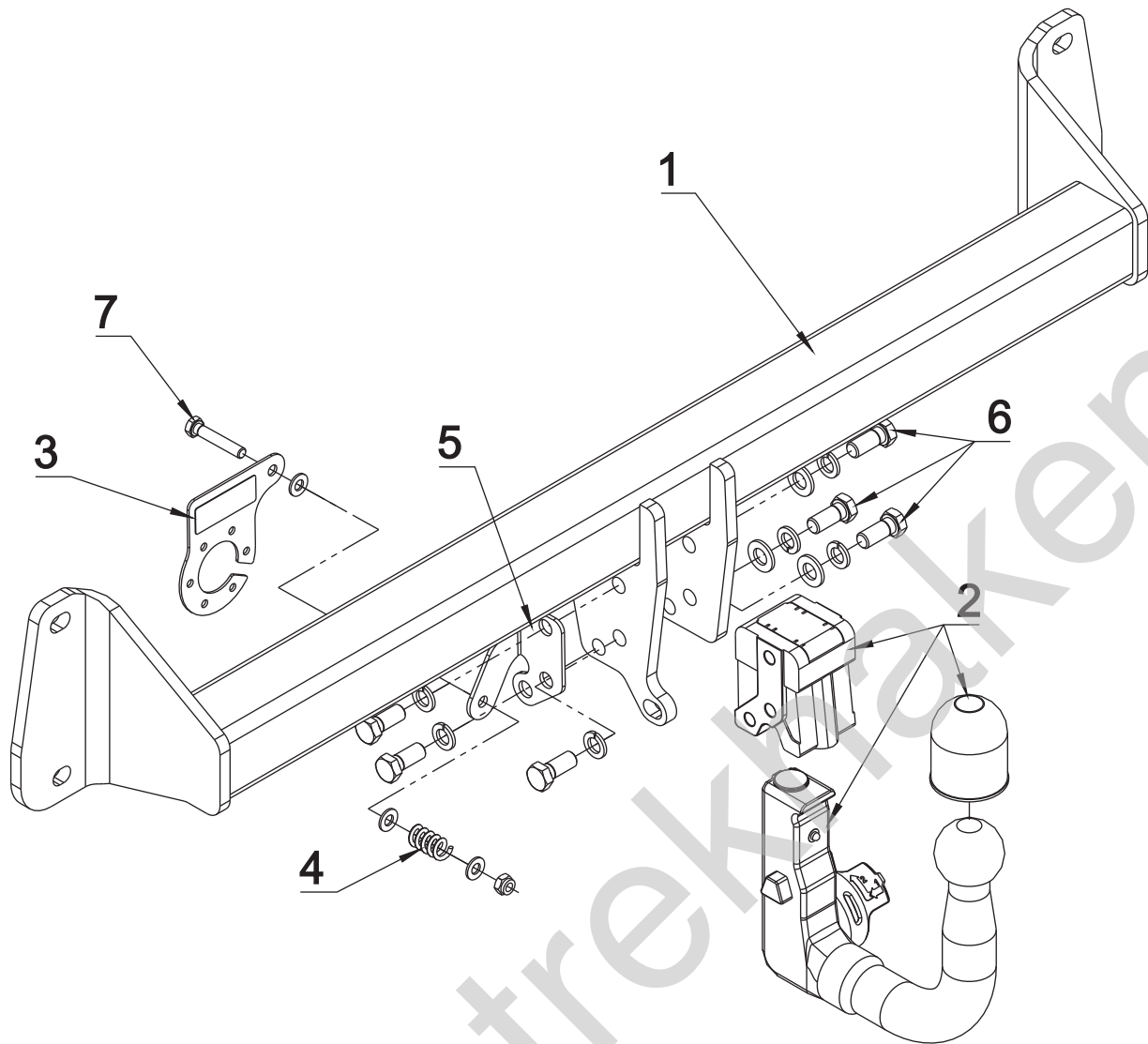

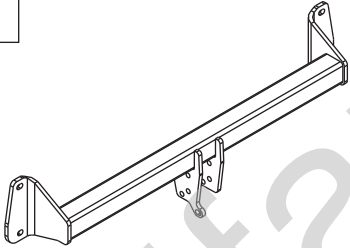

śruba	Nm	M6	M8	M10	M12	M14	M16
klasa 8.8		9,9	24	48	83	132	200
klasa 10.9		14	34	67	117	185	285

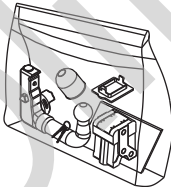
 0 km →  1000 km

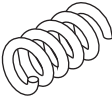

1		x1		6 M12x28	x6
				8 $\varnothing$ 13	x3
				9 $\varnothing$ 8.3	x3
				10 $\varnothing$ 12.2	x6
2		x1		11 M8 (DIN985)	x1
3		x1	Art.nr-KL1B29V		
			Art.nr-BL12B29V		
4		x1			
5		x1			

